



**Support (Black Painted)**



**Wood Screw**



**Screw**



**Nut**



**Clamp**

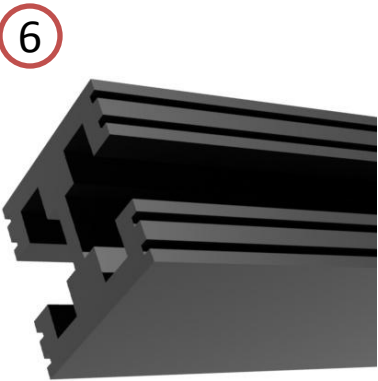

**Aluminum profile**

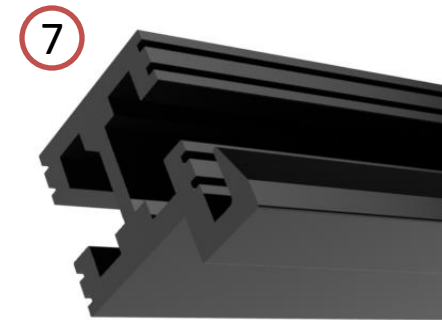

**See Aluminum profile dimensions table**

Part Name		Quantity	
		1 coll.	2 coll.
1	Support (Black Painted)	4	6
2	8 x 60 Wood Screw	8	12
3	M10 x 20 Screw	6	10
4	M10 Nut	6	10
5	Clamp	2	4
6	Aluminum profile	1	1
7	Aluminum profile	1	1

Aluminum profile dimensions (mm)		
Model	1 coll.	2 coll.
2510	1335 x 30 x 30	2670 x 30 x 30
2108	1150 x 30 x 30	2300 x 30 x 30
1808	1050 x 30 x 30	2100 x 30 x 30



1

3

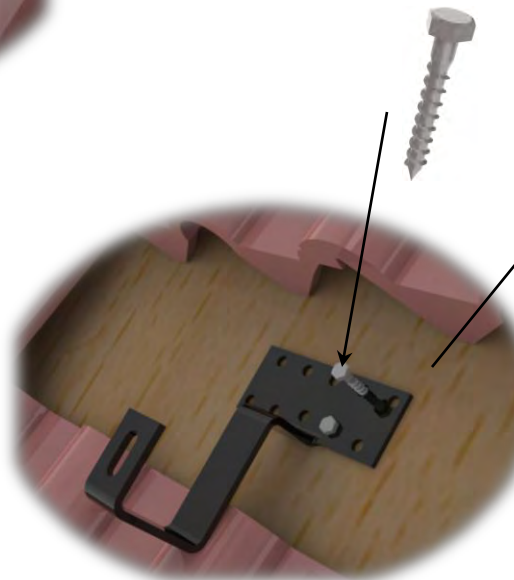
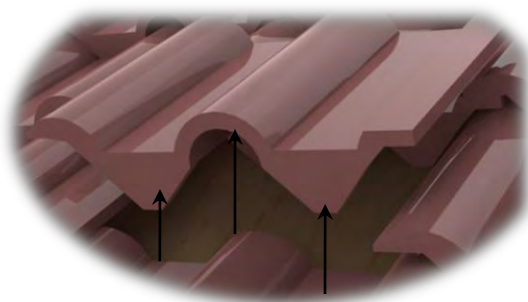
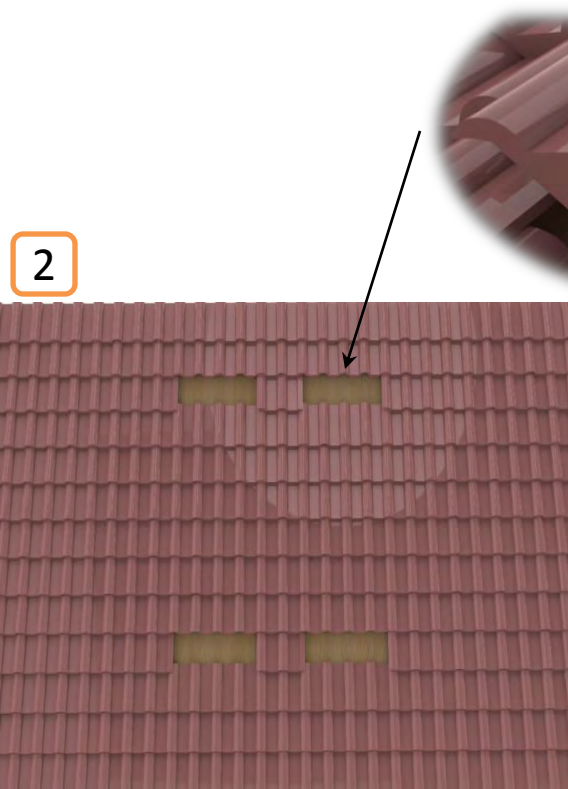

4

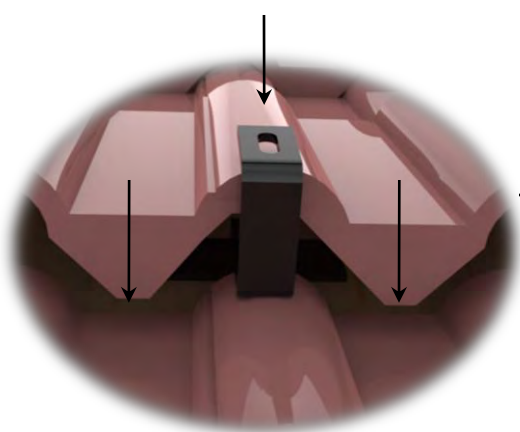

5

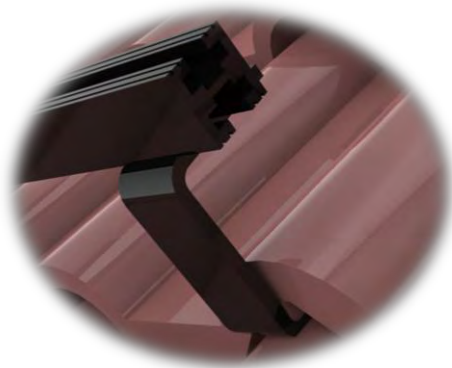
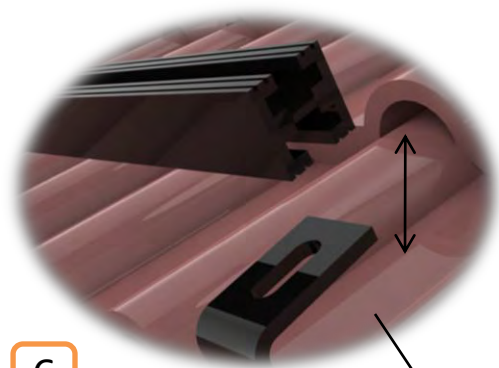

6

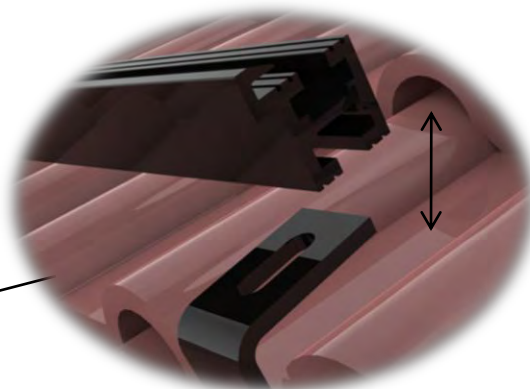

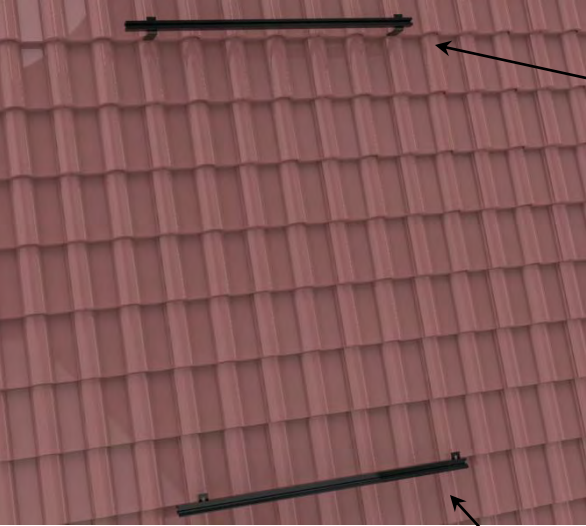

7

8

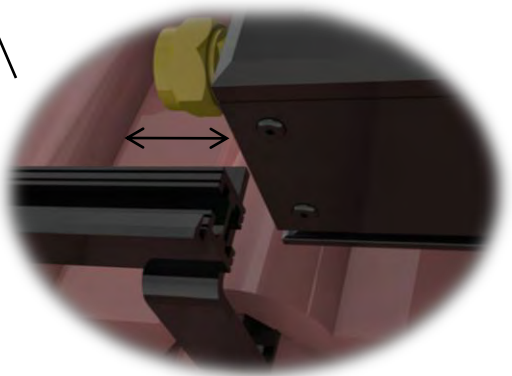
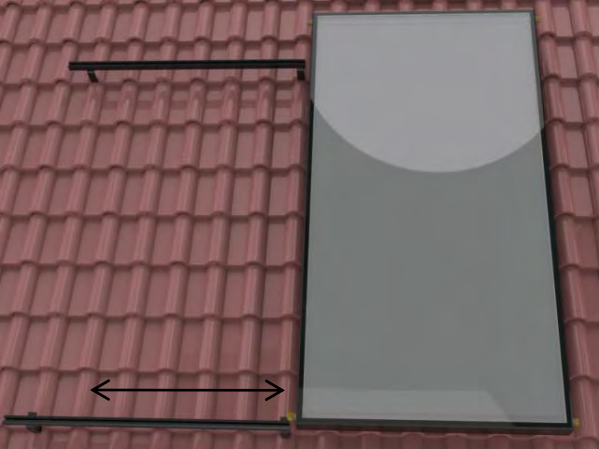

OR

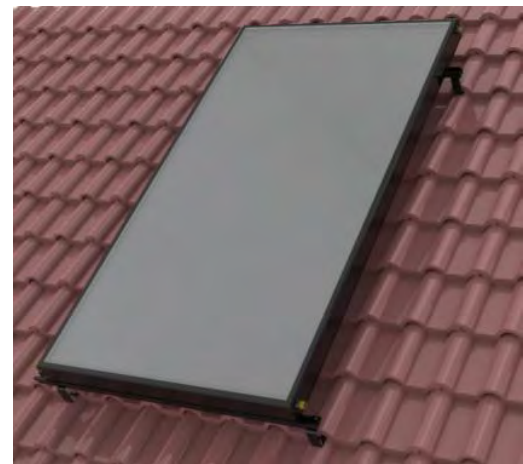
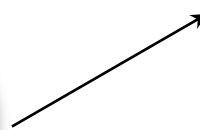
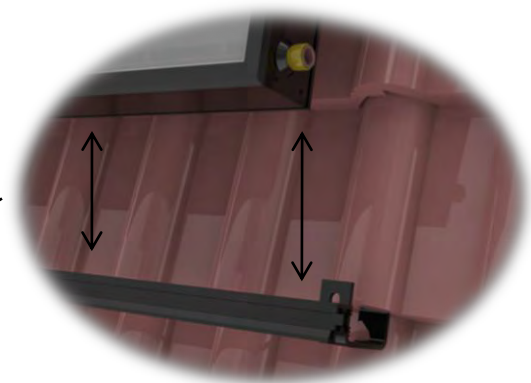
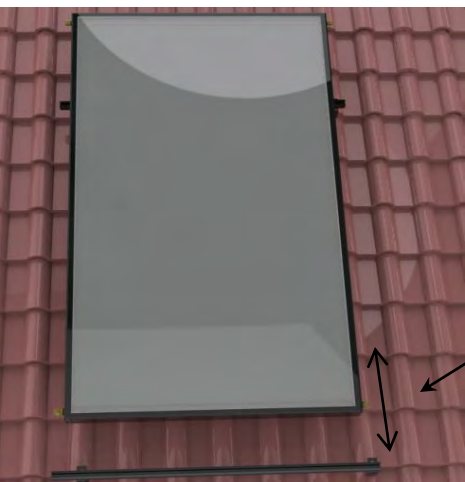

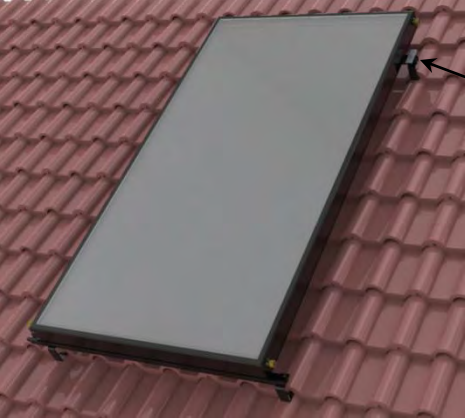

9

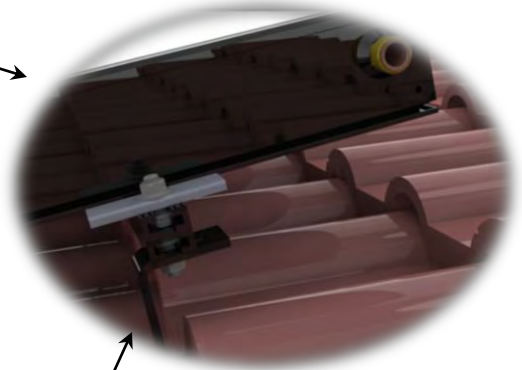

1



2

3

